



BUILDING FEATURES / CARATTERISTICHE COSTRUTTIVE

VESTA valves and solenoid valves with connections **G1/8**, **G1/4** and **G1/2** are available in the 3/2, 5/2 and 5/3 versions, with different forms of actuation (i.e. solenoid / pilot etc).

The choice of high quality materials and the technical solution adopted allows to the valves to reach a good performance even in harsh environmental conditions. The spool, made by a light alloy aluminium, nickel treated by Niploy Process (see fig. **A**) to give its surface a smooth finish and a better resistance to aggressive agent. Its particular shape allows high nominal flow rates (see fig. **D**), and the combination with self lubricating lip rubber seals (see fig. **B**), reduce internal friction (see fig. **C**) and provides the valve with a long lasting durable life span.

Valves and Solenoid valves with connections **G1/8**; **G1/4** and **G1/2** can operate continuously without lubrication (see fig. **E**) and are sealed against working environment.

*Le valvole ed elettrovalvole VESTA con connessioni **G1/8**; **G1/4** e **G1/2** sono disponibili nelle versioni 3/2, 5/2 e 5/3 con più sistemi di attuazione e riposizionamento. Le soluzioni tecniche adottate ed i materiali impiegati hanno permesso di realizzare un prodotto che presenta elevate prestazioni funzionali anche in condizioni di impiego particolarmente gravose.*

*La spola, costruita in lega leggera e progettata per consentire elevate portate nominali (**D**), viene trattata superficialmente al nickel (Niploy Process) (**A**) onde acquisire una durezza maggiore ed una più elevata resistenza agli agenti aggressivi.*

*La combinazione tra la spola e le guarnizioni in elastomero nitrilico con profilo del labbro antiusura (**B**), permette, accanto ad una riduzione degli attriti, un' alta velocità di scambio e cicli di lavoro elevati (**C**), garantendo una maggiore durata della meccanica interna.*

*Tutti i modelli di valvole con connessioni **G1/8**; **G1/4** e **G1/2** possono essere utilizzati anche in assenza di lubrificazione (**E**).*

*L'ermeticità di funzionamento verso l'ambiente di lavoro ne fa inoltre un prodotto adatto all'impiego in settori cosiddetti "difficili" (**F**).*

Nelle pagine che seguono tutte le caratteristiche funzionali di ciascuna valvola sono convalidate dal Dipartimento di Meccanica del Politecnico di Torino.

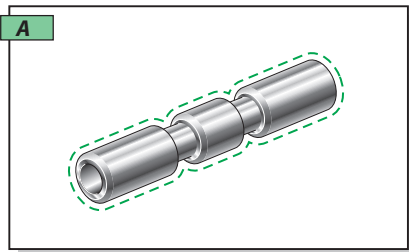

Light alloy spool with Niploy Process treated surface.
Spola in lega leggera con trattamento superficiale Niploy Process.

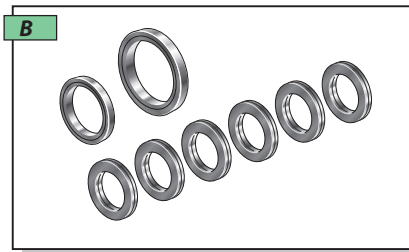

Self lubricating lip rubber seals.
Guarnizioni in elastomero nitrilico con profilo del labbro antiusura.

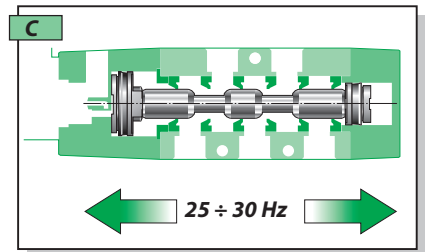

High working frequency.
Alta velocità di scambio per cicli di lavoro elevati.

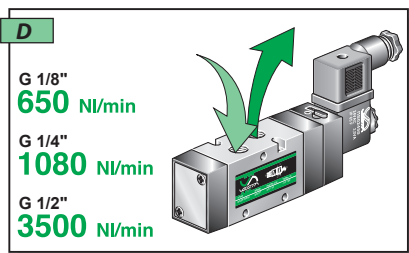

High nominal air flow.
Alta portata nominale.

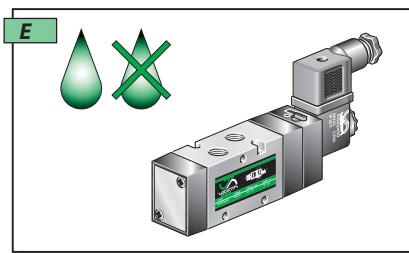

Possibility of operating continuously without lubrication.
Possibilità di funzionamento continuo privo di lubrificazione.

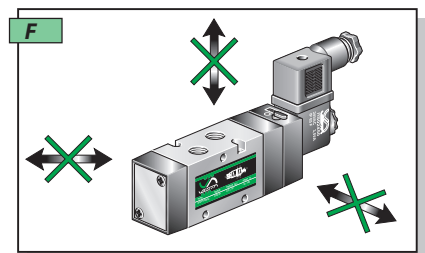

Protected against working environment (no spring return versions).
Protezione di funzionamento verso l'ambiente di lavoro (non nelle versioni con ritorno a molla).

WORKING PRINCIPLE / PRINCIPIO DI FUNZIONAMENTO

In the example here below, when the 5/2 valve **E52W1S018 - 02450** stands in the normal position, ports **4 - 5** and **1 - 2** are connected and the position is kept thanks to the pressure assured to the smallest piston (right side of the valve). When the valve is actuated, the same pressure is fed to the biggest piston. It's bigger surface create a force which allows to the spool to move and therefore to connect ports **4 - 1** and **2 - 3**.

In the mechanical spring version, the valve is kept in the normal position by a mechanical spring.

In the bistable versions, the position of the valve remains in its last switched state.

*Il principio di funzionamento del distributore 5/2 (nell'esempio la valvola a comando elettropneumatico e riposizionamento a molla pneumatica **E52W1S018 - 02450**) consiste nel mantenere costantemente in pressione il pistone di riposizionamento (fig. 1), utilizzando la fonte d'aria compressa presente nel condotto di alimentazione **1**, collegando le vie **1 - 2** e **4 - 5**.*

*L'eccitazione del solenoide mette in comunicazione il condotto in pressione **1** con la camera dove é alloggiato il pistone di comando.*

*Quest'ultimo, avendo un'area di spinta maggiore del pistone di riposizionamento, sposta la spola in modo tale da collegare i canali **1 - 4** e **2 - 3** (fig. 2).*

Diseccitando il solenoide si ripristina la posizione iniziale.

Nei sistemi bistabili (doppio comando elettropneumatico o doppio comando pneumatico) in assenza di segnale rimangono i collegamenti dell'ultimo azionamento.

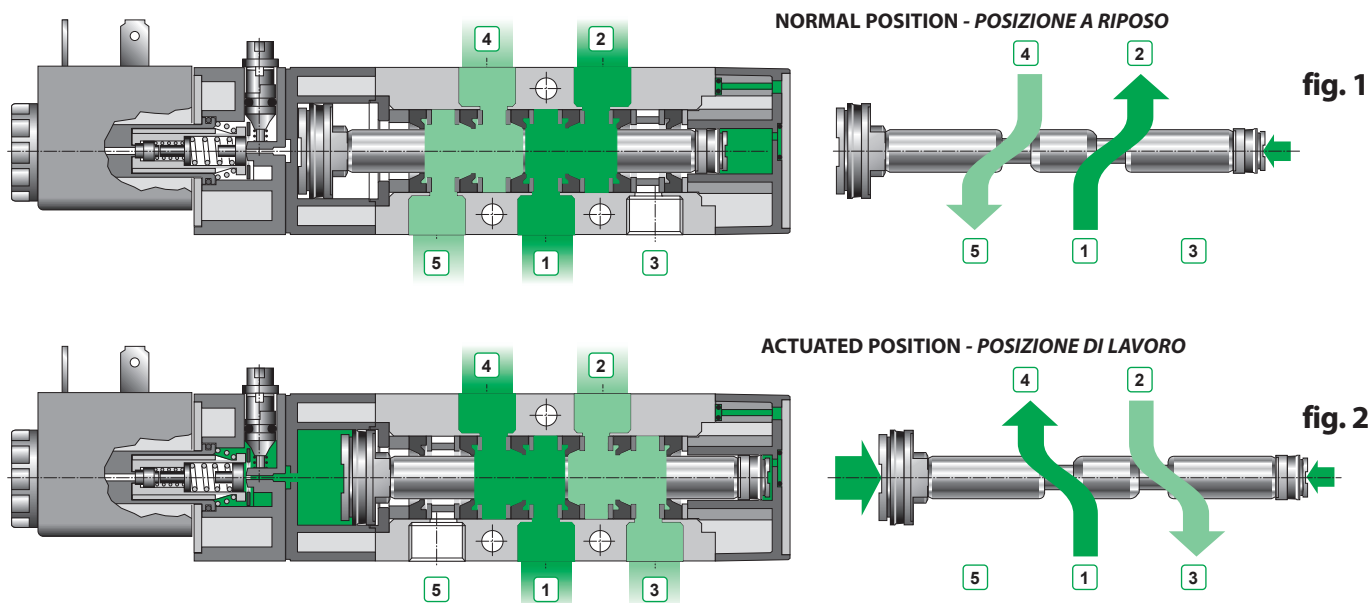

MANUAL OVERRIDING / AZIONAMENTO COMANDO MANUALE

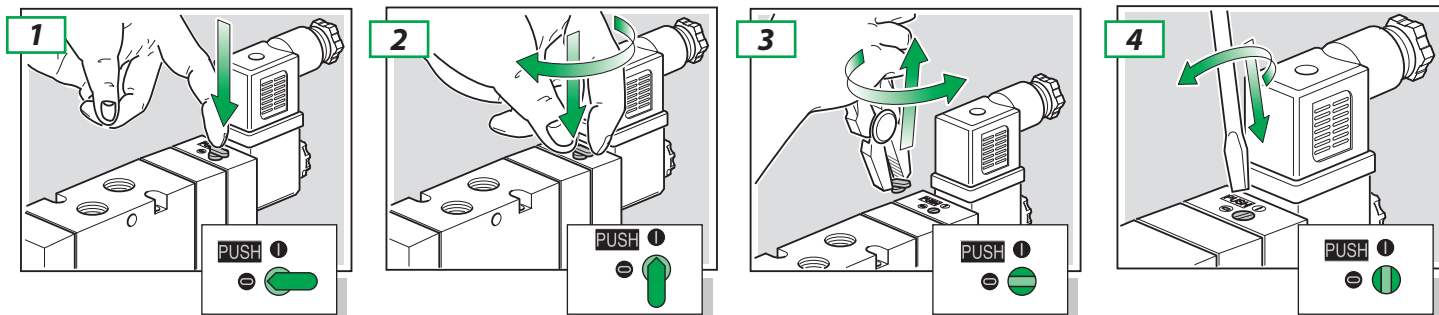

Push to actuated valve without locking. **Relise the button to get back to normal position.**

*Per azionare la valvola, durante la fase di collaudo con pressione in linea senza collegamento elettrico, premere la leva del comando manuale. **Rilasciare per ripristinare la condizione di riposo.***

To active the valve permanently push the M/O (manual override) and rotate clockwise 90°. **To return to normal position, push the M/O again and turn 90° anticlockwise.**

*Per azionare la valvola in modo permanente premere la leva del comando manuale e ruotare in senso orario sino alla posizione 1. **Ruotare in senso antiorario per ripristinare la condizione di riposo.***

Should the M/O no longer be required, then turn the M/O anticlockwise until it breaks off.

Terminato il collaudo ruotare in senso antiorario la leva sino alla rottura.

Should the M/O be required after breaking off, then a screwdriver may be used.

Per interventi successivi sul comando manuale usare un adeguato cacciavite ed operare come al punto 1 o 2.



INDEX / INDICE

(*) ATEX versions see / Versioni ATEX vedi P. B-113

VALVES AND SOLENOID VALVES / VALVOLE ED ELETTROVALVOLE G1/2

pag. B-24

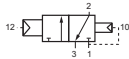

V32V1P612

SINGLE PNEUMATIC PILOT - INTERNAL PRESSURE RETURN
COMANDO PNEUMATICO - MOLLA PNEUMATICA

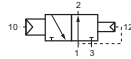

V32V1P912

SINGLE PNEUMATIC PILOT - INTERNAL PRESSURE RETURN
COMANDO PNEUMATICO - MOLLA PNEUMATICA

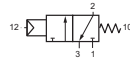

(*) **V32V1P6M2**

SINGLE PNEUMATIC PILOT - SPRING RETURN
COMANDO PNEUMATICO - MOLLA MECCANICA

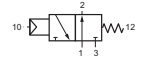

(*) **V32V1P9M2**

SINGLE PNEUMATIC PILOT - SPRING RETURN
COMANDO PNEUMATICO - MOLLA MECCANICA

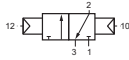

(*) **V32V2P012**

DOUBLE PNEUMATIC PILOT
DOPPIO COMANDO PNEUMATICO

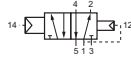

V52V1P012

SINGLE PNEUMATIC PILOT - INTERNAL PRESSURE RETURN
COMANDO PNEUMATICO - MOLLA PNEUMATICA

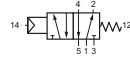

(*) **V52V1PM12**

SINGLE PNEUMATIC PILOT - SPRING RETURN
COMANDO PNEUMATICO - MOLLA MECCANICA

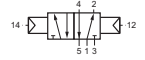

(*) **V52V2P012**

DOUBLE PNEUMATIC PILOT
DOPPIO COMANDO PNEUMATICO

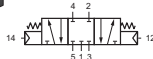

(*) **V53V2P612**

DOUBLE PNEUMATIC PILOT - CENTER POSITION CLOSED
DOPPIO COMANDO PNEUMATICO - CENTRI CHIUSI



(*) **V53V2P912**

DOUBLE PNEUMATIC PILOT - CENTER POSITION OPEN
DOPPIO COMANDO PNEUMATICO - CENTRI APERTI

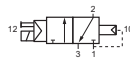

E32W1S612 -

SINGLE SOLENOID VALVE - INTERNAL PRESSURE RETURN
COMANDO ELETTROPNEUMATICO - MOLLA PNEUMATICA

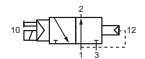

E32W1S912 -

SINGLE SOLENOID VALVE - INTERNAL PRESSURE RETURN
COMANDO ELETTROPNEUMATICO - MOLLA PNEUMATICA

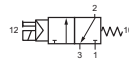

(*) **E32W1S6M2 -**

SINGLE SOLENOID VALVE - SPRING RETURN
COMANDO ELETTROPNEUMATICO - MOLLA MECCANICA

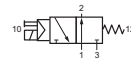

(*) **E32W1S9M2 -**

SINGLE SOLENOID VALVE - SPRING RETURN
COMANDO ELETTROPNEUMATICO - MOLLA MECCANICA

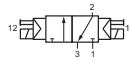
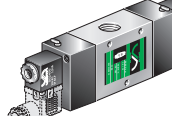

(*) **E32W2S012 -**

DOUBLE SOLENOID VALVE
DOPPIO COMANDO ELETTROPNEUMATICO

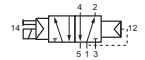

E52W1S012 -

SINGLE SOLENOID VALVE - INTERNAL PRESSURE RETURN
COMANDO ELETTROPNEUMATICO - MOLLA PNEUMATICA

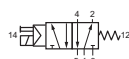

(*) **E52W1SM12 -**

SINGLE SOLENOID VALVE - SPRING RETURN
COMANDO ELETTROPNEUMATICO - MOLLA MECCANICA

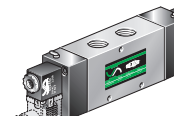

(*) **E52W2S012 -**

DOUBLE SOLENOID VALVE
DOPPIO COMANDO ELETTROPNEUMATICO

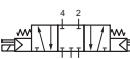

(*) **E53W2S612 -**

DOUBLE SOLENOID VALVE - CENTER POSITION CLOSED
DOPPIO COMANDO ELETTROPNEUMATICO - CENTRI CHIUSI

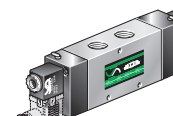

(*) **E53W2S912 -**

DOUBLE SOLENOID VALVE - CENTER POSITION OPEN
DOPPIO COMANDO ELETTROPNEUMATICO - CENTRI APERTI

(*) ATEX versions see / Versioni ATEX vedi P. B-113

DIRECT ACTING SOLENOID VALVES AND SPARE PARTS / ELETTROVALVOLE A COMANDO DIRETTO E RICAMBI

pag. B-35

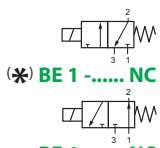

(*) **BE 1 -** NC

BE 1 - NO
(Coil: 5W) - (Solenoid: 5W)

DIRECT ACTING SOLENOID VALVE
ELETTROVALVOLA A COMANDO DIRETTO

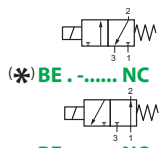

(*) **BE -** NC

BE - NO
(Coil: 5W) - (Solenoid: 5W)

DIRECT ACTING SOLENOID VALVES - MANIFOLD
ELETTROVALVOLE A COMANDO DIRETTO IN BATTERIA

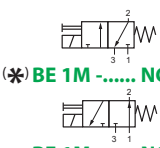

(*) **BE 1M -** NC

BE 1M - NO
(Coil: 5W) - (Solenoid: 5W)

DIRECT ACTING SOLENOID VALVE WITH MANUAL CONTROL
ELETTROVALVOLA A COMANDO DIRETTO CON CONTROLLO MANUALE

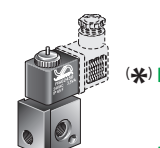

(*) **BE . M -** NC

BE . M - NO
(Coil: 5W) - (Solenoid: 5W)

DIRECT ACTING SOLENOID VALVES WITH MANUAL CONTROL - MANIFOLDS
ELETTROVALVOLE A COMANDO DIRETTO CON CONTROLLO MANUALE IN BATTERIA

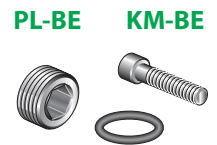

PL-BE

KM-BE

GE 1

GE

MBE-4-....

pag. B-35

MBE-8NC-....

MBE-8NO-....

MS

CEP-1

SET1 1/2 SG
SET2 1/2 SG

pag. B-36

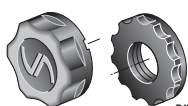

DIRECT ACTING SOLENOID VALVES 3/2 TUBE Ø4mm - MANIFOLD
ELETTROVALVOLE A COMANDO DIRETTO 3/2 TUBO Ø4mm IN BATTERIA

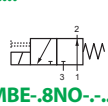
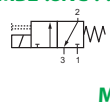
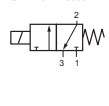

DIRECT ACTING SOLENOID VALVES 3/2 G1/8 - MANIFOLD
ELETTROVALVOLE A COMANDO DIRETTO 3/2 G1/8 IN BATTERIA

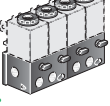

VALVES AND SOLENOID VALVES G1/2 SERIES / VALVOLE ED ELETTROVALVOLE SERIE G1/2
G1/2

Port connections	G1/2
Pilot connections	G1/8
Flow section	Ø 15 mm
Environment temperature range	-10 °C ÷ +50 °C
Temperature range of medium	0 °C ÷ +40 °C
Lubrication	Not required
Medium	Filtered air
Reference temperature	+20 °C
Reference pressure	6 bar

3/2 VALVES AND SOLENOID VALVES	
Fixing	n°3 holes Ø 5,5
Nominal air flow	3500 NI/min
Fluid conductance "C"	12,88 NI/s bar
Critical pressure ratio "b"	0,393

5/2 VALVES AND SOLENOID VALVES	
Fixing	n°3 holes Ø 5,5
Nominal air flow	3500 NI/min
Fluid conductance "C"	12,88 NI/s bar
Critical pressure ratio "b"	0,396

5/3 VALVES AND SOLENOID VALVES	
Fixing	n°3 holes Ø 5,5
Nominal air flow	3000 NI/min
Fluid conductance "C"	10,76 NI/s bar
Critical pressure ratio "b"	0,42

Connessioni di lavoro	G1/2
Connessioni operatori	G 1/8
Diametro nominale	Ø 15 mm
Temperatura ambiente	-10 °C ÷ +50 °C
Temperatura fluido	0 °C ÷ +40 °C
Lubrificazione	Non necessaria
Fluido	Aria filtrata
Temperatura nominale	+20 °C
Pressione nominale	6 bar

VALVOLE ED ELETTROVALVOLE 3/2	
Fissaggio	n°3 fori laterali Ø 5,5
Portata nominale	3500 NI/min
Valore conduttanza "C"	12,88 NI/s bar
Rapporto critico delle pressioni "b"	0,393

VALVOLE ED ELETTROVALVOLE 5/2	
Fissaggio	n°3 fori laterali Ø 5,5
Portata nominale	3500 NI/min
Valore conduttanza "C"	12,88 NI/s bar
Rapporto critico delle pressioni "b"	0,396

VALVOLE ED ELETTROVALVOLE 5/3	
Fissaggio	n°3 fori laterali Ø 5,5
Portata nominale	3000 NI/min
Valore conduttanza "C"	3,22 NI/s bar
Rapporto critico delle pressioni "b"	0,265

PNEUMATIC VALVES FEATURES / CARATTERISTICHE VALVOLE PNEUMATICHE

Size Taglia	Code Codice	Nominal pilot pressure (bar) Pressione di pilotaggio nominale (bar)	Nominal max frequency (Hz) Frequenza max nominale (Hz)	Operating pressure range (bar) Pressione di esercizio (bar)
G 1/2"	V32V1P612	4 bar (10 bar)	12 Hz	2,2 ÷ 10 bar
	V32V1P912	4 bar (10 bar)	12 Hz	2,2 ÷ 10 bar
	V32V1P6M2	2,85 bar	8 Hz	1,5 ÷ 10 bar
	V32V1P9M2	2,85 bar	8 Hz	1,5 ÷ 10 bar
	V32V2P012	1,3 bar	14 Hz	1,2 ÷ 10 bar
	V52V1P012	4 bar (10 bar)	12 Hz	2,5 ÷ 10 bar
	V52V1PM12	2,85 bar	7 Hz	1,5 ÷ 10 bar
	V52V2P012	1,3 bar	13 Hz	1,5 ÷ 10 bar
	V53V2P612	3,2 bar	6 Hz	1,5 ÷ 10 bar
	V53V2P912	3,2 bar	6 Hz	1,5 ÷ 10 bar

SOLENOID VALVES FEATURES / CARATTERISTICHE ELETTROVALVOLE

Size Taglia	Code Codice	Average actining response (ms) Tempo medio di risposta in eccitazione (ms)		Average disactioning response (ms) Tempo medio di risposta in diseccitazione (ms)		Nominal max frequency (Hz) Frequenza max nominale (Hz)		Operating pressure range (bar) Pressione di esercizio (bar)
		AC	DC	AC	DC	AC	DC	
G 1/2"	E32W1S612	43 ms	45 ms	55 ms	55 ms	13 Hz	12 Hz	2,2 ÷ 10 bar
	E32W1S912	43 ms	45 ms	55 ms	55 ms	13 Hz	12 Hz	2,2 ÷ 10 bar
	E32W1S6M2	47 ms	49 ms	60 ms	60 ms	8 Hz	8 Hz	2,5 ÷ 10 bar
	E32W1S9M2	47 ms	49 ms	60 ms	60 ms	8 Hz	8 Hz	2,5 ÷ 10 bar
	E32W2S012	22 ms	26 ms	22 ms	26 ms	16 Hz	15 Hz	1,2 ÷ 10 bar
	E52W1S012	47 ms	49 ms	58 ms	58 ms	11 Hz	10 Hz	2,5 ÷ 10 bar
	E52W1SM12	47 ms	49 ms	60 ms	60 ms	8 Hz	8 Hz	2,5 ÷ 10 bar
	E52W2S012	24 ms	28 ms	24 ms	28 ms	14 Hz	13 Hz	1,5 ÷ 10 bar
	E53W2S612	49 ms	49 ms	60 ms	60 ms	6 Hz	6 Hz	3 ÷ 10 bar
	E53W2S912	49 ms	49 ms	60 ms	60 ms	6 Hz	6 Hz	3 ÷ 10 bar



SOLENOID VALVE / 3/2

SINGLE SOLENOID VALVE - INTERNAL PRESSURE RETURN
 COMANDO ELETTROPNEUMATICO - RIPOSIZIONAMENTO MOLLA PNEUMATICA

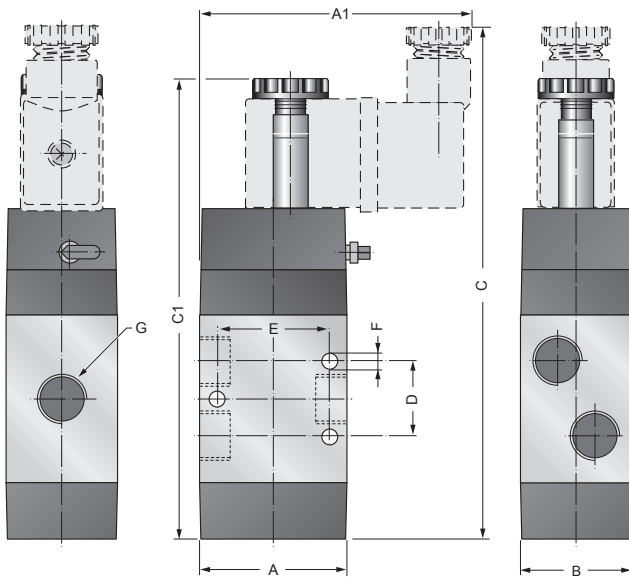

Size Taglia	A	A1	B	C	C1	D	E	ØF	G
1/8	30	63	26	133	119	18	23	4,25	G1/8
1/4	40	73	30	140	125	20	30	4,25	G1/4
1/2	60	60	40	181	167	40	50	5,5	G1/2

E32W1S.1. -

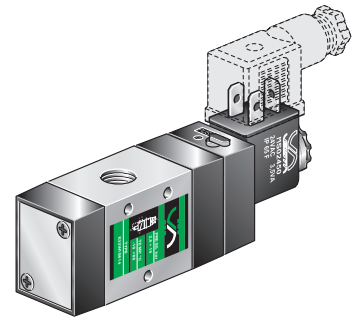

DIAGRAMS / DIAGRAMMI

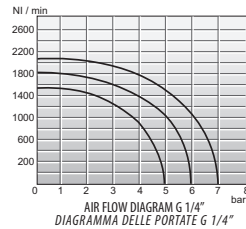
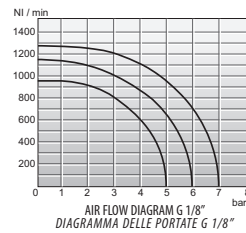

SIMBOLS / SIMBOLI

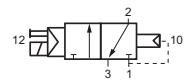

E32W1S61. -.....

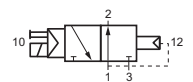

E32W1S91. -.....

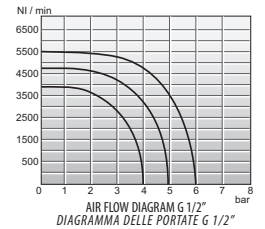

SOLENOID VALVE / ELETTROVALVOLA 3/2

SINGLE SOLENOID VALVE - SPRING RETURN
 COMANDO ELETTROPNEUMATICO - RIPOSIZIONAMENTO MOLLA MECCANICA

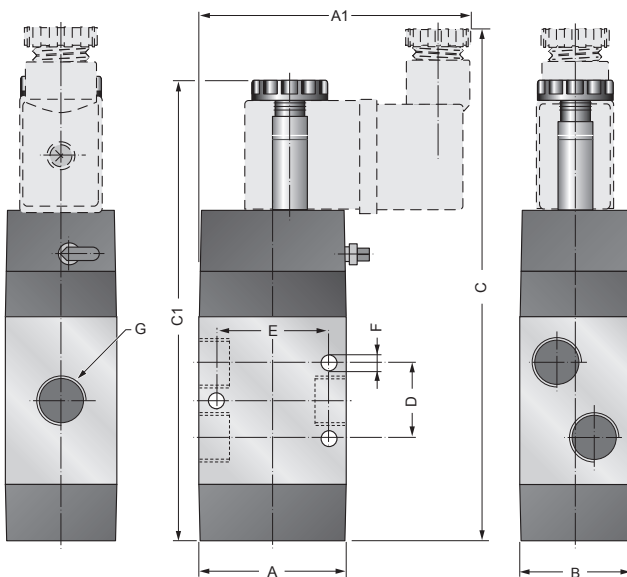

(*) ATEX versions see / Versioni ATEX vedi P.

Size Taglia	A	A1	B	C	C1	D	E	ØF	G
1/8	30	63	26	133	119	18	23	4,25	G1/8
(*) 1/4	40	73	30	140	125	20	30	4,25	G1/4
(*) 1/2	60	60	40	172	158	40	50	5,5	G1/2

E32W1S.M. -

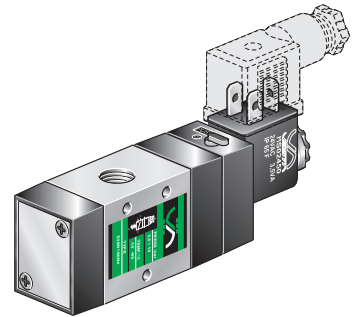

DIAGRAMS / DIAGRAMMI

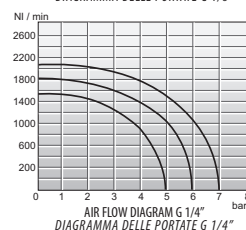
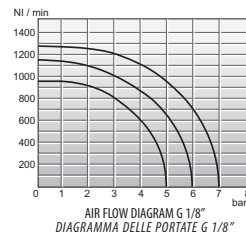

SIMBOLS / SIMBOLI

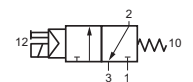

E32W1S6M. -.....

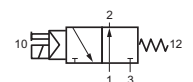

E32W1S9M. -.....

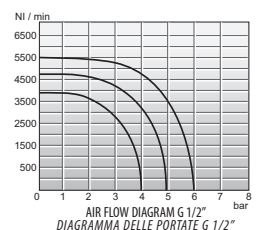

E32W2S01. -

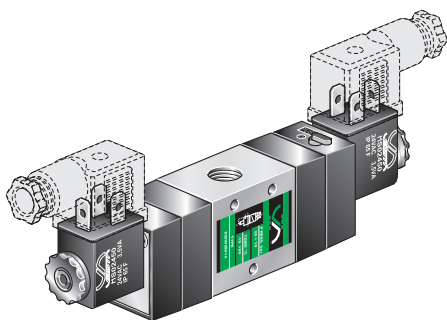

SOLENOID VALVE / 3/2
DOUBLE SOLENOID VALVE / *DOPIO COMANDO ELETTROPNEUMATICO*

SIMBOL / SIMBOLO

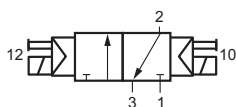

DIAGRAMS / DIAGRAMMI

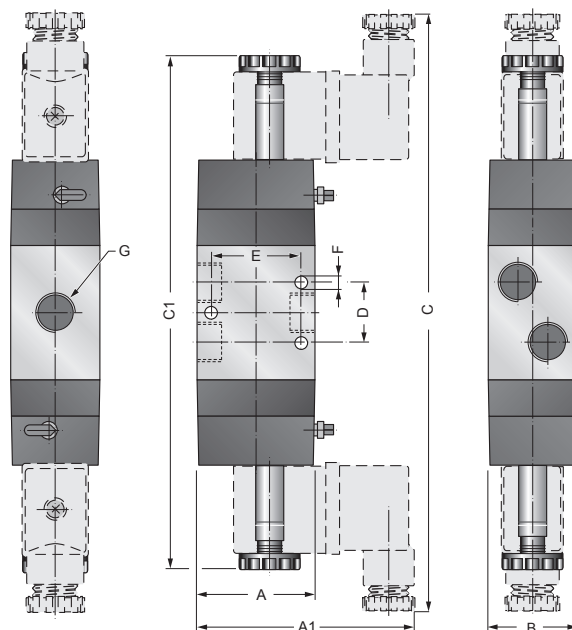
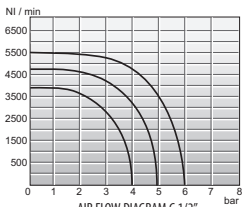
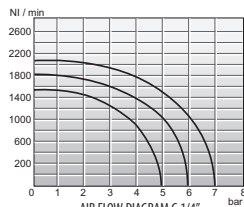
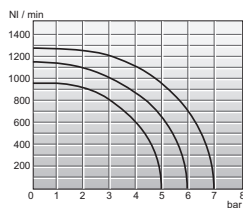

(*) ATEX versions see / *Versioni ATEX vedi P. B-113*

Size Taglia	A	A1	B	C	C1	D	E	ØF	G
1/8	30	63	26	197	169	18	23	4,25	G1/8
(*) 1/4	40	73	30	203	175	20	30	4,25	G1/4
(*) 1/2	60	60	40	240	212	40	50	5,5	G1/2

E52W1S.1. -

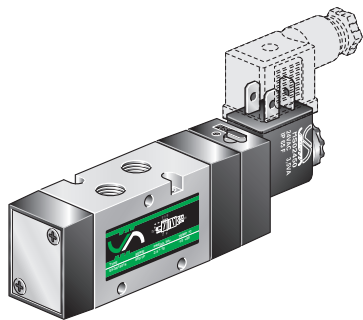

SOLENOID VALVE / 5/2
SINGLE SOLENOID VALVE / *COMANDO ELETTROPNEUMATICO*

SIMBOLS / SIMBOLI

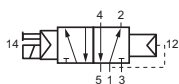

DIAGRAMS / DIAGRAMMI

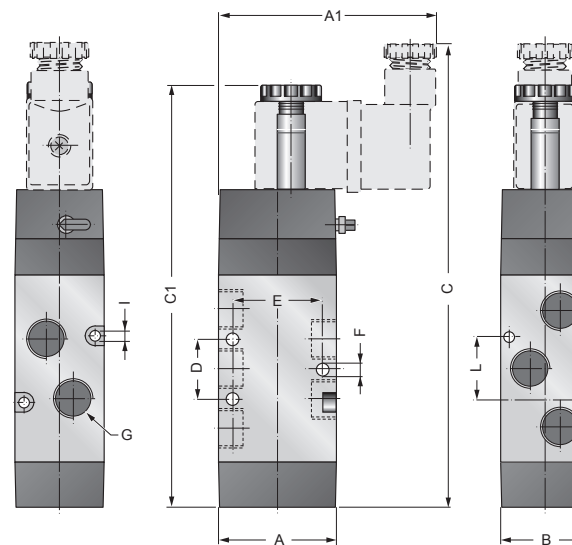
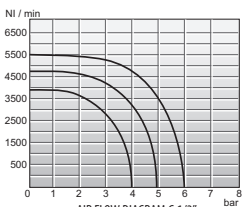
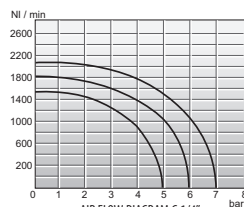
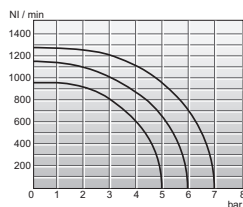

(*) ATEX versions see / *Versioni ATEX vedi P. B-113*

Size Taglia	A	A1	B	C	C1	D	E	ØF	G	ØI	L
1/8	30	63	26	150	136	18	23	4,25	G1/8	3,25	28,6
(*) 1/4	40	73	30	158	143	20	30	4,25	G1/4	3,25	21
(*) 1/2	60	60	40	221	207	40	50	5,5	G1/2	—	—



SOLENOID VALVE / 5/2

DOUBLE SOLENOID VALVE / *DOPIO COMANDO ELETTROPNEUMATICO*

E52W2S01. -

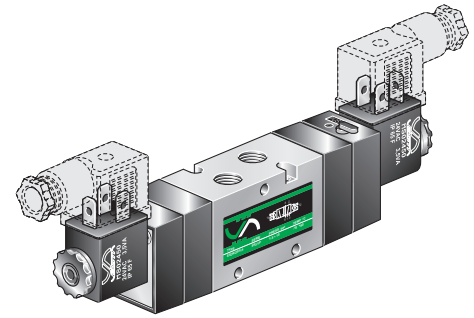
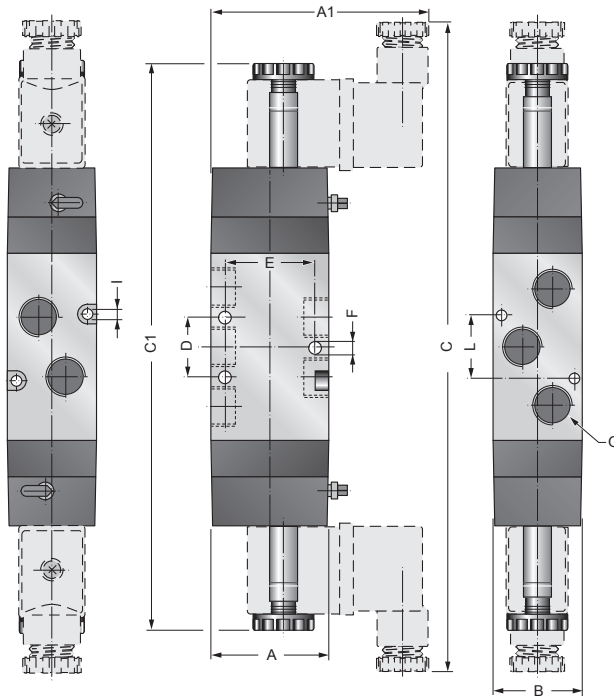

DIAGRAMS / DIAGRAMMI

SIMBOL / SIMBOLO

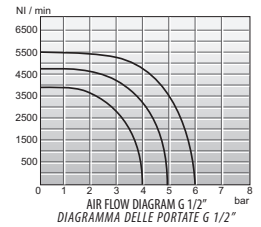
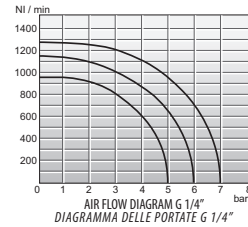
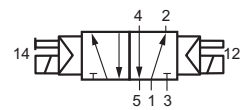
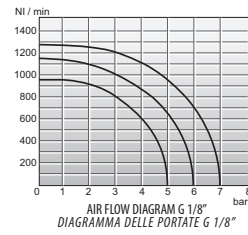

Size Taglia	A	A1	B	C	C1	D	E	ØF	G	ØI	L
1/8	30	63	26	215	186	18	23	4,25	G1/8	3,25	28,6
(*) 1/4	40	73	30	220	191	20	30	4,25	G1/4	3,25	21
(*) 1/2	60	60	40	280	252	40	50	5,5	G1/2	—	—

(*) ATEX versions see P. B-113
Versioni ATEX vedi P. B-113

SOLENOID VALVE / 5/3

DOUBLE SOLENOID VALVE / *DOPIO COMANDO ELETTROPNEUMATICO*

E53W2S. 1. -

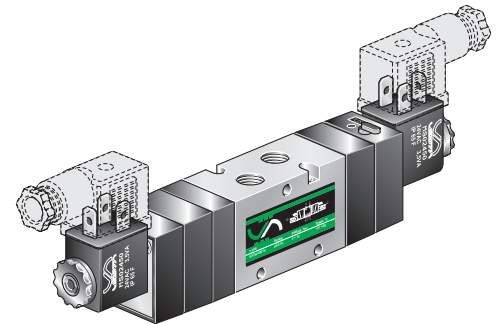
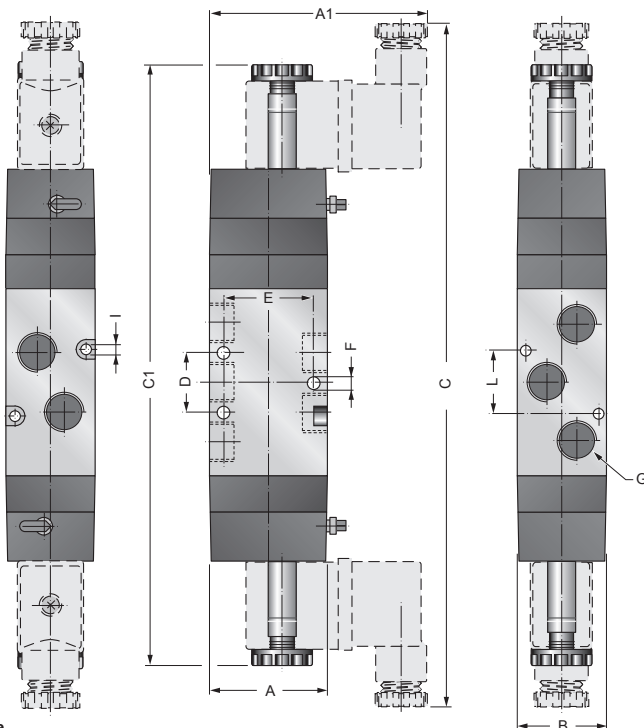

DIAGRAMS / DIAGRAMMI

SIMBOLS / SIMBOLI

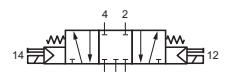
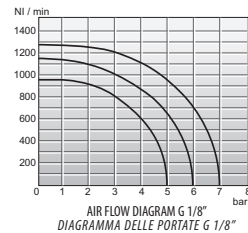

E53W2S61 -

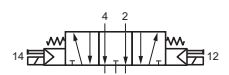

E53W2S91 -

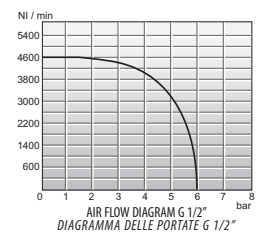
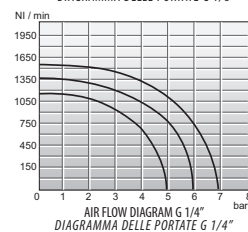

Size Taglia	A	A1	B	C	C1	D	E	ØF	G	ØI	L
1/8	30	63	26	227	198	18	23	4,25	G1/8	3,25	28,6
1/4	40	73	30	232	203	20	30	4,25	G1/4	3,25	21
1/2	60	60	40	280	252	40	50	5,5	G1/2	—	—

(*) ATEX versions see P. B-113
Versioni ATEX vedi P. B-113

V32V1P . 1.

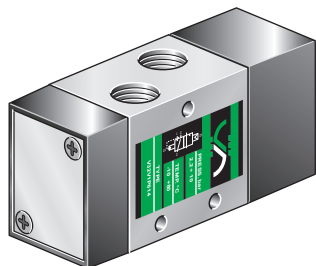

VALVE / VALVOLA 3/2
SINGLE PNEUMATIC PILOT - INTERNAL PRESSURE RETURN
COMANDO PNEUMATICO - RIPOSIZIONAMENTO A MOLLA PNEUMATICA

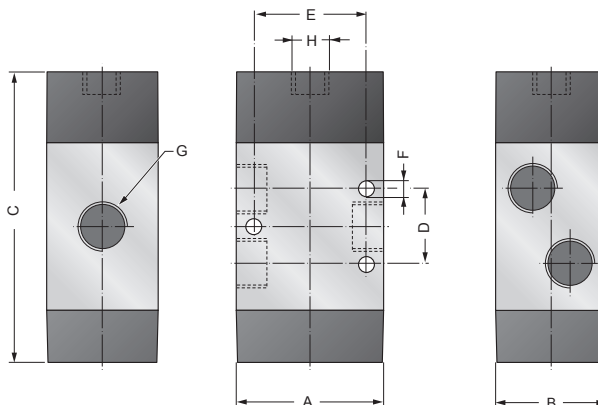

SIMBOLS / SIMBOLI

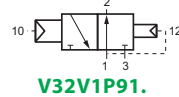
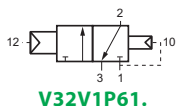

DIAGRAMS / DIAGRAMMI

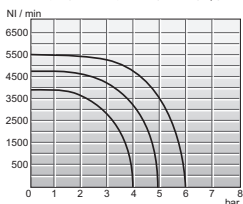
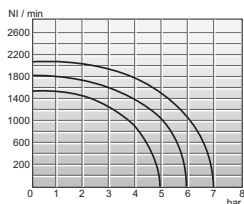
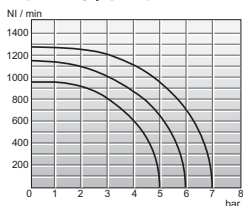
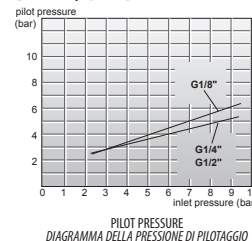
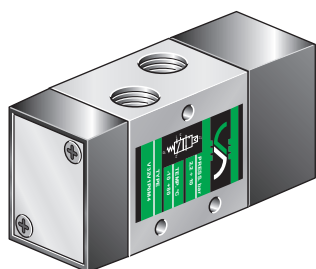

DIAGRAM / DIAGRAMMA



Size Taglia	A	B	C	D	E	ØF	G	H
G1/8	30	26	74	18	23	4,25	G1/8	G1/8
G1/4	40	30	81,5	20	30	4,25	G1/4	G1/8
G1/2	60	40	127	40	50	5,5	G1/2	G1/8

V32V1P . M.



VALVE / VALVOLA 3/2
SINGLE PNEUMATIC PILOT - SPRING RETURN
COMANDO PNEUMATICO - RIPOSIZIONAMENTO A MOLLA MECCANICA

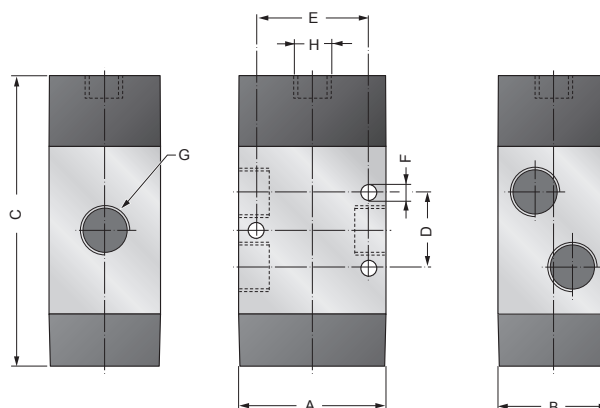

SIMBOLS / SIMBOLI

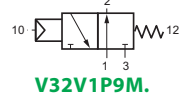
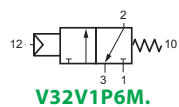

DIAGRAMS / DIAGRAMMI

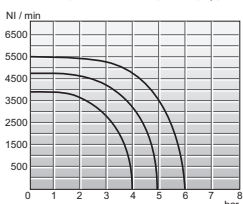
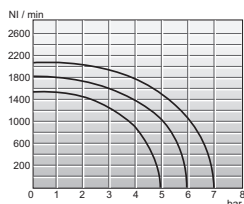
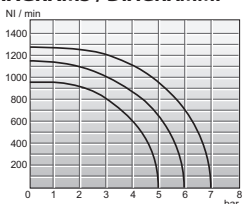
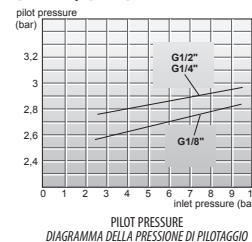

DIAGRAM / DIAGRAMMA



(*) ATEX versions see / Versioni ATEX vedi P. B-113

Size Taglia	A	B	C	D	E	ØF	G	H
G1/8	30	26	74	18	23	4,25	G1/8	G1/8
(*) G1/4	40	30	81,5	20	30	4,25	G1/4	G1/8
(*) G1/2	60	40	118	40	50	5,5	G1/2	G1/8



VALVE / VALVOLA 3/2
DOUBLE PNEUMATIC PILOT / *DOPIO COMANDO PNEUMATICO*

V32V2P01.

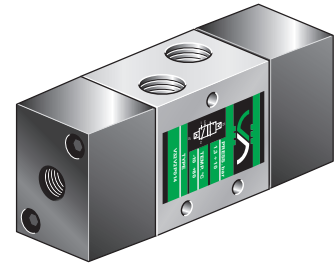
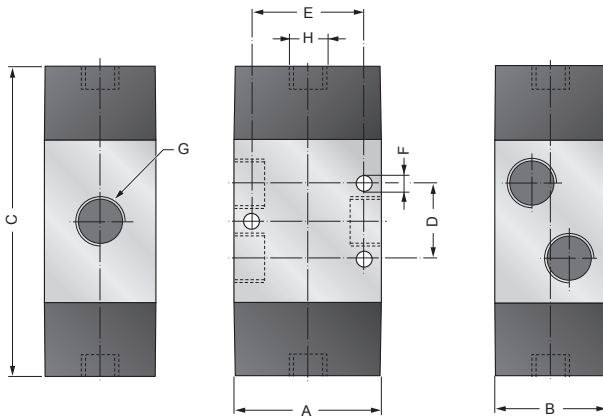

DIAGRAMS / DIAGRAMMI

SIMBOL / SIMBOLO

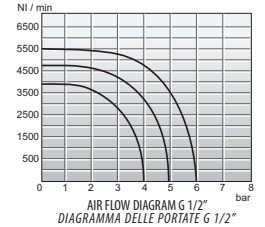
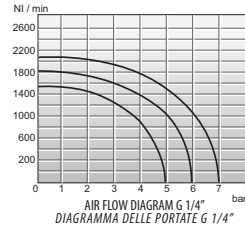
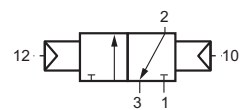
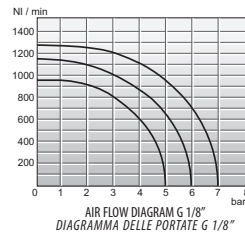
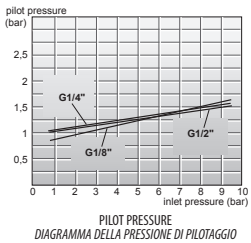

DIAGRAM / DIAGRAMMA



(*) ATEX versions see / *Versioni ATEX vedi P. B-113*

Size Taglia	A	B	C	D	E	ØF	G	H
G1/8	30	26	79	18	23	4,25	G1/8	G1/8
(*) G1/4	40	30	87	20	30	4,25	G1/4	G1/8
(*) G1/2	60	40	132	40	50	5,5	G1/2	G1/8

VALVE / VALVOLA 5/2
SINGLE PNEUMATIC PILOT / *COMANDO PNEUMATICO*

V52V1P . 1.

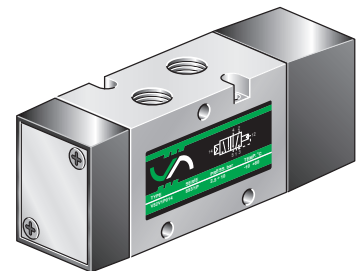
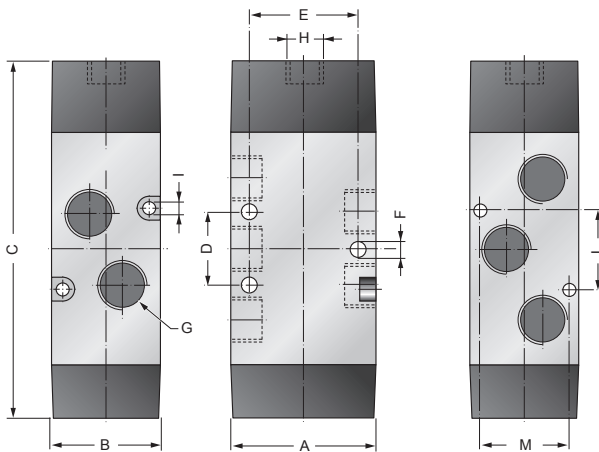

DIAGRAMS / DIAGRAMMI

SIMBOLS / SIMBOLI

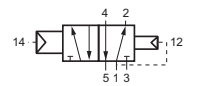
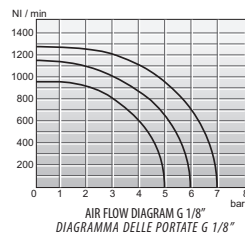

V52V1P01.

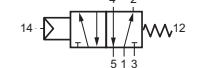

V52V1PM1.

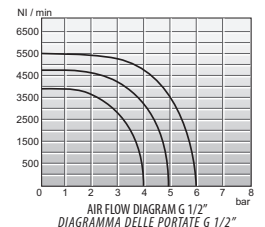
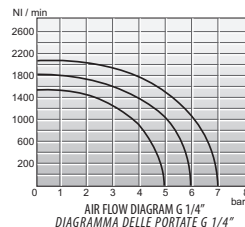
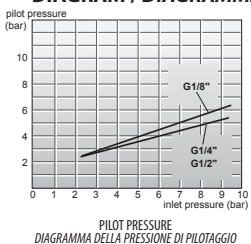

DIAGRAM / DIAGRAMMA



(*) ATEX versions see / *Versioni ATEX vedi P. B-113*

Size Taglia	A	B	C	D	E	ØF	G	H	ØI	L	M
1/8	30	26	91	18	23	4,25	G1/8	G1/8	3,25	28,6	20
(*) 1/4	40	30	100	20	30	4,25	G1/4	G1/8	3,25	21	24,6
(*) 1/2	60	40	167	40	50	5,5	G1/2	G1/8	—	—	—

V52V2P . 1.

VALVE / VALVOLA 5/2
DOUBLE PNEUMATIC PILOT / DOPPIO COMANDO PNEUMATICO

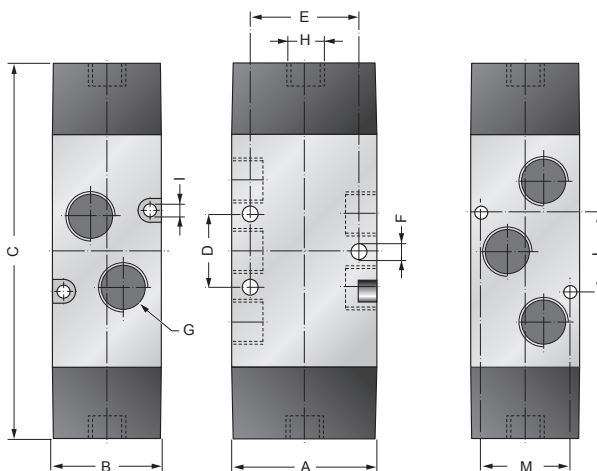
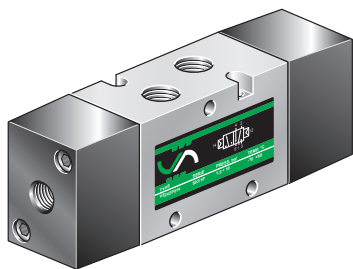

SIMBOLS / SIMBOLI



V52V2P01.



V52V2PD1.

DIAGRAMS / DIAGRAMMI

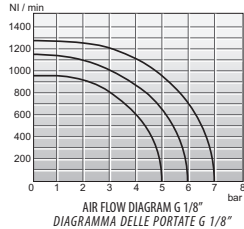
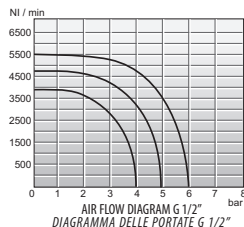
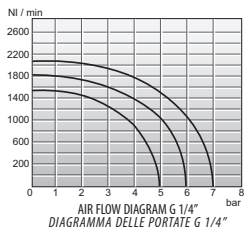

(*) ATEX versions see / Versioni ATEX vedi P. B-113

Size Taglia	A	B	C	D	E	ØF	G	H	ØI	L	M
1/8	30	26	96	18	23	4,25	G1/8	G1/8	3,25	28,6	20
(*) 1/4	40	30	105	20	30	4,25	G1/4	G1/8	3,25	21	24,6
(*) 1/2	60	40	172	40	50	5,5	G1/2	G1/8	—	—	—

DIAGRAM / DIAGRAMMA

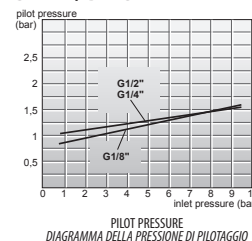

V53V2P . 1.

VALVE / VALVOLA 5/3
DOUBLE PNEUMATIC PILOT / DOPPIO COMANDO PNEUMATICO

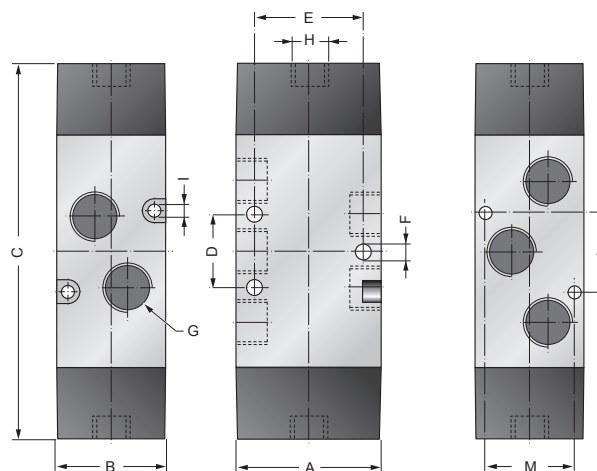
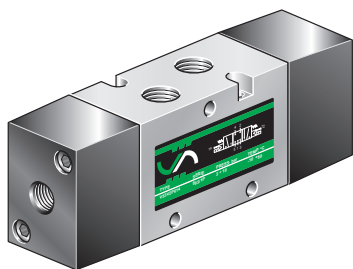

SIMBOLS / SIMBOLI



V53V2P61.



V53V2P91.

DIAGRAMS / DIAGRAMMI

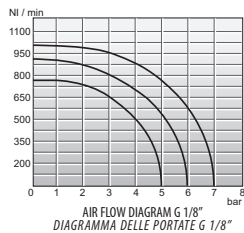
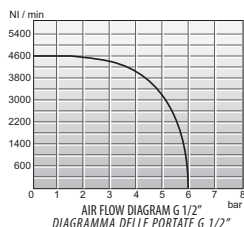
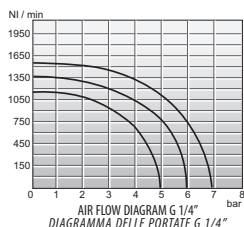

(*) versions see / Versioni vedi P. B-113

Size Taglia	A	B	C	D	E	ØF	G	H	ØI	L	M
1/8	30	26	108	18	23	4,25	G1/8	G1/8	3,25	28,6	20
1/4	40	30	105	20	30	4,25	G1/4	G1/8	3,25	21	24,6
1/2	60	40	192	40	50	5,5	G1/2	G1/8	—	—	—

DIAGRAM / DIAGRAMMA

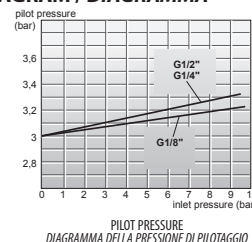



MS

COIL
SOLENOIDE

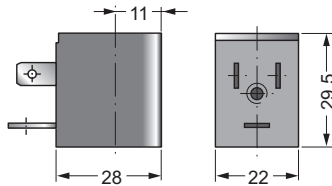

CODES / CODICI

Ordination code Codice ordinazione	Voltage Tensione
MS01200	12 V DC
MS02400	24 V DC
MS02450	24 V 50/60Hz AC
MS11050 (*)	110 V 50/60Hz AC
MS22050 (*)	220 V 50/60Hz AC

(*) Please see page / Vedi pag. **B-37**

TECHNICAL FEATURES

Standard voltage	12, 24 V DC 24, 110, 220 V AC (50/60 Hz)
Solenoid characteristics	2,5 Watt in DC; 3,5 VA in AC
Tension	± 10%
Ambient temperature range	-20 °C ÷ +50 °C
Degree of	Class F
Expy	Incapsulated

CARATTERISTICHE TECNICHE

Tensione standard	12, 24 V DC 24, 110, 220 V AC (50/60 Hz)
Prestazioni bobina	2,5 Watt in DC; 3,5 VA in AC
Tensione nominale	± 10% a bobina calda
Limiti di temperatura ambiente	-20 °C ÷ +50 °C
Protezione	IP 65 secondo IEC 144 con connettore e guarnizioni montate
Bobina	Classe F, Filo rame classe 200 °C
Sovrastampatura	Resina epossidica

CEP-1

SOLENOID CONNECTOR
CONNETTORE

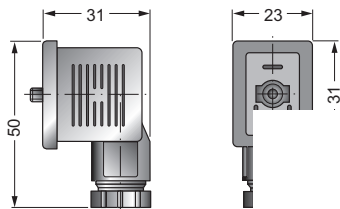
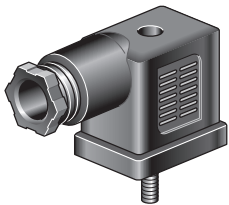

CODES / CODICI

Description Descrizione	Code Codice	Tension Tensione
Universal connector Connettore universale	CEP-1	All tension Tutte le tensioni
Connector with led Connettore con led	CEP-1 L 10 / 50 CEP-1 L 70 / 250	10/50 V AC / DC 70/250 V AC / DC
Connector with led and varistor Connettore con led e varistore	CEP-1 LV 24 CEP-1 LV 110 CEP-1 LV 220	24 V AC / DC 110 V AC / DC 220 V AC / DC

TECHNICAL FEATURES

Wire connection	With screwed terminals
Gland thread	PG 9
Number of poles	2 Poles + earth
Housing colour	Black, transparent in the led version.

CARATTERISTICHE TECNICHE

Connessione cavi	Con morsetti a vite
Filettatura passacavo	PG 9
N° Poli	2 Poli + terra
Colori connettore	Nero, trasparente nelle versioni con led.

SET . 1/2 SG

SEALS KIT
KIT GUARNIZIONI DI RICAMBIO

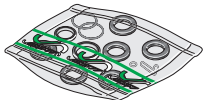

Seals kit code - Codice del kit

SET 1 1/2 SG: for G1/2 **mono-stable** valves - per valvole **monostabili** G1/2.

SET 2 1/2 SG: for G1/2 **bi-stable** valves - per valvole **bistabili** G1/2.

Example / Esempio: **E52W1SM12-02400** → **SET 1 1/2 SG** **E52W2S012-02400** → **SET 2 1/2 SG**



INSTRUCTIONS FOR USE OF THE FOLLOWING VESTA PRODUCTS

IL PRESENTE MANUALE DI USO E MANUTENZIONE È VALIDO PER I SEGUENTI PRODOTTI VESTA:

COILS SINGLES OR ASSEMBLED ON VALVES / SOLENOIDI SINGOLI O ASSEMBLATI SU ELETTROVALVOLE:

MS11050, MS22050, CS11050, CS22050, SCN11050, SCN22050

Please pay attention to the following Vesta products:

Coil and connector offer protection from dust and water to IP65 only when correctly installed with the fixing screw and rubber gasket which are supplied as standard (grommet, coil seal, "O" ring).

Prescrizioni di montaggio per preservare il grado di protezione IP65

Per preservare il grado di protezione IP65 del collegamento elettrico è necessario eseguire il montaggio nel seguente modo:

- Prima di effettuare il collegamento elettrico dei cavi al connettore infilare nel cavo stesso il pressacavo avvitando il serracavo sul connettore.
- Montare la guarnizione bobina fra bobina e connettore, quindi fissare il connettore alla bobina con l'apposita vite, avvitandola adeguatamente.
- Montare quindi la bobina sulla valvola posizionando l'anello di tenuta (OR) nell'apposita sede della bobina.

Ground connection

Ground connection must be secure and adequate.

Messa a terra

La bobina prevede il morsetto a terra che deve essere collegato opportunamente all'impianto di messa a terra dell'installazione che deve essere realizzata a regola d'arte.

Electrical connection

When choosing the cable for electrical connections, take into account the location and environment of the installation (ex. Following the CEI 60204-1 standard).

Collegamento elettrico

I conduttori utilizzati per il collegamento devono essere scelti e montati a regola d'arte tenuto conto dell'ambiente e delle condizioni di utilizzo nonché delle caratteristiche elettriche di impiego (tensione e corrente di esercizio). Si consiglia di seguire, ove applicabile, la pertinente normativa applicabile (ad es. CEI EN 60204-1).

Should the above instructions not be followed to the letter Vesta Automation will not be hold responsible.

L'installatore e l'utilizzatore sono tenuti ad attenersi scrupolosamente alle indicazioni impartite.

Qualsiasi omissione solleva Vesta Automation s.r.l. da ogni responsabilità e danno conseguenti.

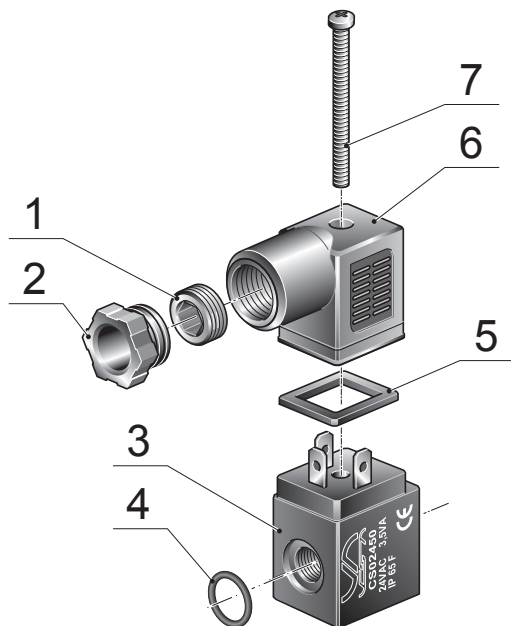

Coils and accessories for solenoid valves.
Solenoidi ed accessori per elettrovalvole.

Position Posizione	Description Descrizione
1	Grommet / Pressacavo
2	Gland nut / Serracavo
3	Solenoid coil / Bobina
4	O-Ring / OR
5	Coil seal / Guarnizione bobina
6	Connector / Connettore
7	Fixing screw / Vite